



Navera



Navera headboard with clear glass shelf and LED lighting



Navera at a glance

- 3 Cabinet widths for hinged doors **200/250/300 cm**
- 4 Cabinet widths for sliding doors **200/240/280/320 cm**
- Cabinet height **223 cm**
- 2 chest of drawers widths **80/120 cm**
- 1 chest of drawers height **90 cm**
- Interior decor linen look twist
- 2 bed widths **160/180 cm**
- 1 Bed length **200 cm**
- 4-fold adjustable lying height
- Bedside cabinet width **50 cm**
- Bed unit with upholstered backrest, panels and 2 floating bedside cabinets
- Bed lights & clear glass base with **LED lighting**

6 front colours / 2 carcass colours / 2 handle colours / 1 upholstery colour

Front colours:



Carcass colours:



Handle colours:



Upholstery colour:



Truro	Tregolls Road, TR1 1SB	01872 222 226
St Austell	8 Manfield Way, Holmbush, PL25 3HQ	01726 70711
Wadebridge	Bridgend, PL27 6DA	01208 814 242
Hayle	4 Fore Street, Copperhouse, TR27 4DY	01736 755 700

Decor examples

Completely unicoloured – handle fitments, lattice bars and runner-style legs in stainless steel or black



Unicolour in combination with unicoloured decor – lattice bars and runner-style legs in stainless steel or black



Unicolour in combination with wooden decor – lattice bars and runner-style legs in stainless steel or black



Truro	Tregolls Road, TR1 1SB	01872 222 226
St Austell	8 Manfield Way, Holmbush, PL25 3HQ	01726 70711
Wadebridge	Bridgend, PL27 6DA	01208 814 242
Hayle	4 Fore Street, Copperhouse, TR27 4DY	01736 755 700

Hinged door wardrobes

1. Please select the colour of the doors A:	2. Please select the colour of the doors B:	3. Please select the carcass colour:	Interior of each wardrobe section: 2 shelves 1 hanging rail
Price group PG 1 – Decors	Price group PG 1 – Decors	P1 Perla L1 Basalt	
P1 Perla Y1 Terra L1 Basalt K1 Imitation artisan oak E9 Imitation silver-grey oak	P1 Perla L1 Basalt	4. Please select the handle colour:	
	Price group PG 2 – Crystal mirror	322 Stainless steel 324 black	
	G79 Crystal mirror		Interior finish Twist linen look

Hinged door wardrobes	Height 223 cm
Internal depth 58 cm	
<p>4 doors 2 doors A le+ri 2 doors B in the centre</p> <p>N°</p>	<p>W200 H223 D62</p> <p>75 205 21</p>
<p>5 doors 2 doors A le+ri 3 doors B in the centre</p> <p>N°</p>	<p>W250 H223 D62</p> <p>75 255 21</p>
<p>6 doors 2 doors A le+ri 4 doors B in the centre</p> <p>N°</p>	<p>W300 H223 D62</p> <p>75 305 21</p>



Handle version 148L

Pelmets with side elements and pelmets with passe partout for hinged door wardrobes

Please specify your choice of colour:	
P1 Perla Y1 Terra L1 Basalt	K1 Imitation artisan oak E9 Imitation silver-grey oak

Pelmets with side elements	Pelmets with passe partout
Wardrobe depth with pelmet 64 cm	Wardrobe depth with passe partout 68 cm
<p>for wardrobe width 200 cm</p> <p>N°</p>	<p>for wardrobe width 200 cm</p> <p>N°</p>
<p>W200 H3.2 D12</p> <p>98 200 10</p>	<p>W204 H227 D12</p> <p>98 205 10</p>
<p>for wardrobe width 250 cm</p> <p>N°</p>	<p>for wardrobe width 250 cm</p> <p>N°</p>
<p>W250 H3.2 D12</p> <p>98 250 10</p>	<p>W254 H227 D12</p> <p>98 255 10</p>
<p>for wardrobe width 300 cm</p> <p>N°</p>	<p>for wardrobe width 300 cm</p> <p>N°</p>
<p>W300 H3.2 D12</p> <p>98 300 10</p>	<p>W304 H227 D12</p> <p>98 305 10</p>

Truro	Tregolls Road, TR1 1SB	01872 222 226
St Austell	8 Manfield Way, Holmbush, PL25 3HQ	01726 70711
Wadebridge	Bridgend, PL27 6DA	01208 814 242
Hayle	4 Fore Street, Copperhouse, TR27 4DY	01736 755 700

Sliding door wardrobes

1.+2. Select the colour of the door panels A and the colour of the door panels B:	3. Select the colour for the contrasting decor:
Price group PG 1 – Decors P1 Perla L1 Basalt Price group PG 2 – Crystal mirror G79 Crystal mirror	P1 Perla Y1 Terra L1 Basalt K1 Imitation artisan oak E9 Imitation silver-grey oak
	4. Please select the carcass colour:
	P1 Perla L1 Basalt
	5. Please select the colour of the handle fittings/door lattice bars:
	322 Stainless steel/Stainless steel 332 Basalt/Black

Interior of each wardrobe section:
2 shelves
1 hanging rail

Interior finish Twist linen look

Handle fitment version 173



Sliding door wardrobes	Height 223 cm
Internal depth 58 cm	
<div style="display: flex; justify-content: space-between; width: 100px; border-bottom: 1px solid black; margin-bottom: 5px;"> 100 100 </div> <div style="display: flex; justify-content: space-around; width: 100px; border: 1px solid black; margin-bottom: 5px;"> <div style="width: 40px; height: 40px; border: 1px solid black; text-align: center; font-size: 8px;">A</div> <div style="width: 40px; height: 40px; border: 1px solid black; text-align: center; font-size: 8px;">B</div> </div> <div style="display: flex; justify-content: space-around; width: 100px; border: 1px solid black;"> <div style="width: 40px; height: 40px; border: 1px solid black; text-align: center; font-size: 8px;">A</div> <div style="width: 40px; height: 40px; border: 1px solid black; text-align: center; font-size: 8px;">B</div> </div> <p>2 doors 2 door panels A left 2 door panels B right</p>	<p>W200 H223 D69</p> <p>35 200 10</p> <p>N°</p>
<div style="display: flex; justify-content: space-between; width: 100px; border-bottom: 1px solid black; margin-bottom: 5px;"> 120 120 </div> <div style="display: flex; justify-content: space-around; width: 100px; border: 1px solid black; margin-bottom: 5px;"> <div style="width: 40px; height: 40px; border: 1px solid black; text-align: center; font-size: 8px;">A</div> <div style="width: 40px; height: 40px; border: 1px solid black; text-align: center; font-size: 8px;">B</div> </div> <div style="display: flex; justify-content: space-around; width: 100px; border: 1px solid black;"> <div style="width: 40px; height: 40px; border: 1px solid black; text-align: center; font-size: 8px;">A</div> <div style="width: 40px; height: 40px; border: 1px solid black; text-align: center; font-size: 8px;">B</div> </div> <p>2 doors 2 door panels A left 2 door panels B right</p>	<p>W240 H223 D69</p> <p>35 240 10</p> <p>N°</p>
<div style="display: flex; justify-content: space-between; width: 100px; border-bottom: 1px solid black; margin-bottom: 5px;"> 40 100 100 40 </div> <div style="display: flex; justify-content: space-around; width: 100px; border: 1px solid black; margin-bottom: 5px;"> <div style="width: 40px; height: 40px; border: 1px solid black; text-align: center; font-size: 8px;">A</div> <div style="width: 40px; height: 40px; border: 1px solid black; text-align: center; font-size: 8px;">B</div> </div> <div style="display: flex; justify-content: space-around; width: 100px; border: 1px solid black;"> <div style="width: 40px; height: 40px; border: 1px solid black; text-align: center; font-size: 8px;">A</div> <div style="width: 40px; height: 40px; border: 1px solid black; text-align: center; font-size: 8px;">B</div> </div> <p>2 doors 2 door panels A left 2 door panels B right</p>	<p>W280 H223 D69</p> <p>35 280 10</p> <p>N°</p>
<div style="display: flex; justify-content: space-between; width: 100px; border-bottom: 1px solid black; margin-bottom: 5px;"> 80 80 80 80 </div> <div style="display: flex; justify-content: space-around; width: 100px; border: 1px solid black; margin-bottom: 5px;"> <div style="width: 40px; height: 40px; border: 1px solid black; text-align: center; font-size: 8px;">A</div> <div style="width: 40px; height: 40px; border: 1px solid black; text-align: center; font-size: 8px;">B</div> </div> <div style="display: flex; justify-content: space-around; width: 100px; border: 1px solid black;"> <div style="width: 40px; height: 40px; border: 1px solid black; text-align: center; font-size: 8px;">A</div> <div style="width: 40px; height: 40px; border: 1px solid black; text-align: center; font-size: 8px;">B</div> </div> <p>2 doors 2 door panels A left 2 door panels B right</p>	<p>W320 H223 D69</p> <p>35 320 10</p> <p>N°</p>







Cushion fittings	
Cushion fittings (set of 2) for sliding doors for a soft stop of both outer doors	<p>N°</p> <p>91 257 18</p>

Cushion fittings	
Opening and anti-collision cushioning for all wardrobes with 2 doors pulls the doors into the „open“ position and dampens the interaction of the doors	<p>N°</p> <p>91 262 18</p>

Truro Tregolls Road, TR1 1SB 01872 222 226
 St Austell 8 Manfield Way, Holmbush, PL25 3HQ 01726 70711
 Wadebridge Bridgend, PL27 6DA 01208 814 242
 Hayle 4 Fore Street, Copperhouse, TR27 4DY 01736 755 700

Lightings for hinged and sliding door wardrobes

Luminous colour warm white is corresponds to approx. 2.700 - 3.500 K (Kelvin)
 Luminous colour neutral white is corresponds to approx. 3.500 - 4.500 K (Kelvin)
 Luminous colour cold white is corresponds to approx. 4.500 - 6.500 K (Kelvin)

Lightings	Set of 1	Set of 2	Set of 3
To be fitted on the wardrobe	1 light 1 foot switch	2 lights 1 foot switch	3 lights 1 foot switch
LED lighting (F; BEL106-Wessel), cold white, with non exchangeable lamps 	W35 H4 97 961 00	W2x35 H4 97 962 00	W3x35 H4 97 963 00
LED lighting (F; BEL106-Wessel), cold white, with non exchangeable lamps 	W35 H4 97 701 00	W2x35 H4 97 702 00	W3x35 H4 97 703 00
LED lighting (F; BEL107-Wessel), cold white, with non exchangeable lamps 	W65 H4 97 891 00	W2x65 H4 97 892 00	W3x65 H4 97 893 00
LED lighting (F; BEL107-Wessel), cold white, with non exchangeable lamps 	W65 H4 97 711 00	W2x65 H4 97 712 00	W3x65 H4 97 713 00

Bed frame

1. Select the colours of the bed frame and the bedside chests:	4. Select the colour of the handle fitments and runner-style legs:	Without slats and mattress All drawers are partially extendable and self-retracting with soft close effect Drawer height H2 = approx. 19 cm Drawer interior colour Twist linen look 
P1 Perla L1 Basalt	322 Stainless steel 324 black	
2. Select the colour of the bedside chest panels:	5. Colour of the upholstered headboard:	
P1 Perla L1 Basalt	G84GB Fabric Amaro grey	
3. Select the colour of the contrasting decor for the bed frame and the bedside chest:		
P1 Perla Y1 Terra L1 Basalt K1 Imitation artisan oak E9 Imitation silver-orev oak		

Bed frame

Height adjustable base in 4 pos. from 29 to 36 cm plus height of mattress and slatted frame

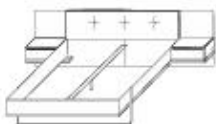

Bed frame

with upholstered headboard, rear wall panels and 2 suspended bedside chests, W 50 cm left and right, each with 1 drawer headboard height 98 cm footboard height 46 cm

N° **59 721 01***

* Please also specify the desired bed size e. g. 180 x 200 cm

Bed frame is available in the following dimensions

Lying area	Measures
150 x 200 cm	W258 H98 D215
180 x 200 cm	W287 H98 D215

Fully extendable drawers available for an additional charge:

All drawers are supplied with partial drawer extension as standard, but can be supplied as fully extendable drawers for an additional charge.





Additional charge for fully extendable version...	Item no.
... for 2 suspended bedside chests	95 912

Truro	Tregolls Road, TR1 1SB	01872 222 226
St Austell	8 Manfield Way, Holmbush, PL25 3HQ	01726 70711
Wadebridge	Bridgend, PL27 6DA	01208 814 242
Hayle	4 Fore Street, Copperhouse, TR27 4DY	01736 755 700



Wooden or glass shelves with LED lighting and bed reading lamps are not available as standard and must be ordered separately.



Storage shelves - Bed lighting

Please specify your choice of colour: P1 Perla Y1 Terra L1 Basalt K1 Imitation artisan oak E9 Imitation silver-grey oak		Version: G11 Clear safety glass	
Shelves To be fitted on bedside chest panel		Glass shelves To be fitted on bedside chest panel	
 Wooden shelf set of 2 25 mm thick		 Clear glass shelves with LED lighting* set of 2 8 mm thick	
N° 47 025 02		N° 47 022 02	
W2x32 D14 max. loading 5 kg		W46 D15 max. loading 5 kg	
Range ACCESSORIES			
Bed lightings To be fitted on bedside chest panel		Bed lightings To be fitted on bedside chest panel	
 LED lighting* flexible set of 2 frosted aluminium 2 switches		 LED lighting* flexible set of 2 black	
N° 97 952 00		N° 97 232 00	
length 2 x 56 cm		length 2 x 52 cm	
<small>*LED lighting (F; BEL100-Halemeier), cold white, with non exchangeable lamps, operating switch located on light fixture</small>		<small>*Dimmable LED lighting (G; BEL149-Wessel), neutral white, with non exchangeable lamps, operated with a touch-sensitive button on the lamp</small>	

Truro	Tregolls Road, TR1 1SB	01872 222 226
St Austell	8 Manfield Way, Holmbush, PL25 3HQ	01726 70711
Wadebridge	Bridgend, PL27 6DA	01208 814 242
Hayle	4 Fore Street, Copperhouse, TR27 4DY	01736 755 700



Range
ACCESSORIES

Drawer dividers

Finish	
X1	Twist linen look
Drawer divider	
for width 50 cm	
For bedside chests	
For drawer height H2	
	W42 H9,5 D34 4 compartments
drawer divider	
N°	91 352 50

Chests

1. Please select the colour of the drawer above:	2. Select the colour of the carcass and the lower drawers:	<p>All drawers are partially extendable and self-retracting with soft close effect</p> <p>Drawer interior finish Twist</p> <p>Drawer height H3 = approx. 25 cm</p>
P1 Perla	P1 Perla	
Y1 Terra	L1 Basalt	
L1 Basalt	3. Select the colour of the handle fittings and runner-style legs:	
K1 Imitation artisan oak	322 Stainless steel	
E9 Imitation silver-grey oak	324 black	

Chests	Height 90 cm
mit Holz-Oberplatte und 2 Kufen (bei Breite 120 cm mit zusätzlichem Stützfuß)	
	W80 H90 D42
3 drawers	N° 42 203 80
	W120 H90 D42
3 drawers	N° 42 203 12



Handle version 193

Fully extendable drawers available for an additional charge:
All drawers are supplied with partial drawer extension as standard, but can be supplied as fully extendable drawers for an additional charge.

Additional charge for fully extendable version...	Item no.
... for chests with 3 drawers	95 913



Truro	Tregolls Road, TR1 1SB	01872 222 226
St Austell	8 Manfield Way, Holmbush, PL25 3HQ	01726 70711
Wadebridge	Bridgend, PL27 6DA	01208 814 242
Hayle	4 Fore Street, Copperhouse, TR27 4DY	01736 755 700

Wall mirror

Please specify your choice of colour:	
P1 Perla	
Y1 Terra	
L1 Basalt	
K1 Imitation artisan oak	
E9 Imitation silver-grey oak	
Wall mirror	
To be fitted on the wall	
	W96 H59
N°	49 028 00

Range ACCESSORIES

Drawer dividers for chests

Finish		
X1 Twist linen look		
Drawer dividers	for width 80 cm	for width 120 cm
For chests		
For drawer height H3		
	W72 H12,5 D34 6 compartments	W112 H12,5 D34 8 compartments
drawer divider	N° 91 353 80	91 353 12